



















Performance

| Series 38 | | |
|------------------|---------------|-----------|
| Torque (Nm) | Nominal#1 | 328 |
| | Max Running#2 | 505 |
| | Max Start-Up | 758 |
| Input Speed | Max (rpm) | 3000 |
| Thermal Limit | Power (kW) | 20.5 |
| Backlash | arcmin | 9 to 16 |
| Efficiency | (%) | 95% - 98% |
| Service Life | (hours) | >10000 |
| Housing Material | | SG Iron |
| Oil Quantity | Litres | 0.75 |
| | Pints | 1.32 |
| Weight (kg) | 2 Way - 2:1 + | 23 |
| | 3 Way - 2:1 + | 23.5 |

Notes:

#1 Nominal torque values at running speeds of 1500 rpm
#2 Maximum running torque value at speed of 10 rpm
Full detailed performance for each unit refer to page 12 & 13

Accessories & Options

| | | | |
|---|---------------------------------|---|----------------------|
|  | Special Gear Ratio |  | Motor Flange |
|  | Extended Drive Shaft |  | Limit Switches |
|  | Drives |  | Light Weight Design |
|  | Reinforced Shaft OR High Torque |  | Breather |
|  | 90° Breather |  | Mounting Feet |
|  | Shaft Cover |  | Stainless Steel |
|  | Submersible |  | Corrosion Protection |
|  | Nuclear Rated |  | Food Grade |
|  | Low Temperature |  | High Temperature |

3 Way Solid Shaft

N380S30-20

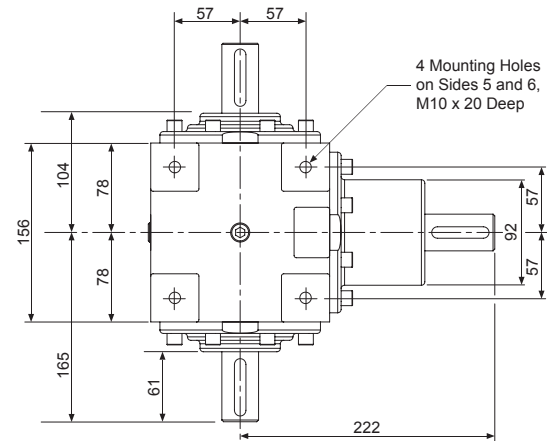
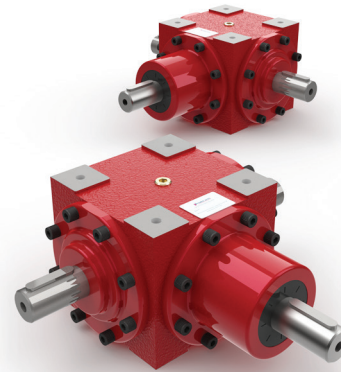

Tapped hole in end of each solid drive shaft - M10 x 25mm Deep

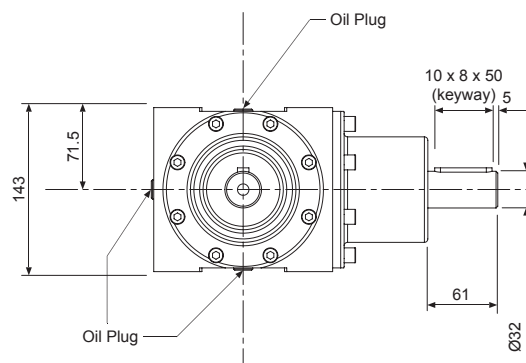

Notes:

1. All dimensions in mm unless otherwise stated
2. Dimensions subject to change without notice